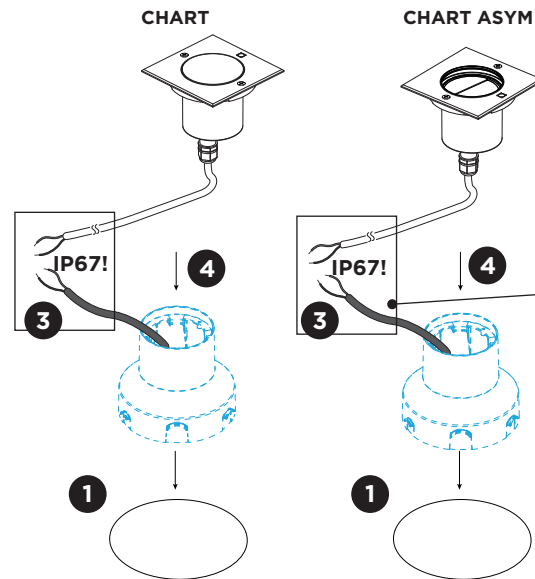



CHART 1.2/1.6 & CHART ASYM 1.2/1.6

INSTALLATION INSTRUCTIONS | APRIL 2022

with ground housing



Included:
waterproof connectors:
 L
N

Optional:
IP68 connection box:
order ref. 73240706 = 2 WAYS 2x1,5 Ø6-8mm

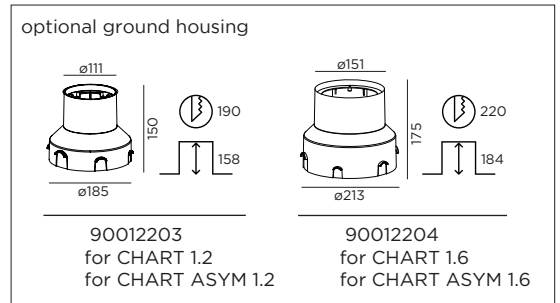
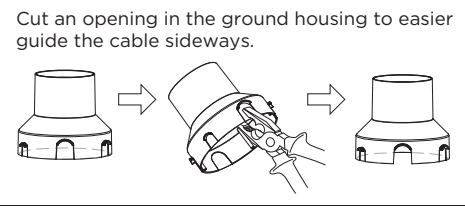

DIMENSIONS

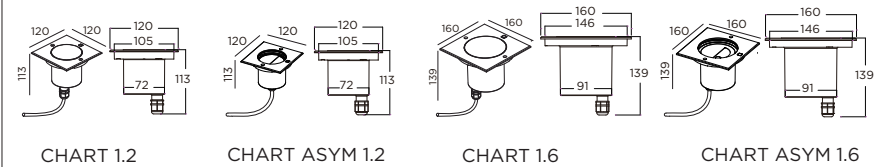

MOUNTING INSTRUCTION WITH GROUND HOUSING

- 1 Make a hole in the ground according to the prescribed dimensions (of the ground housing).
- 2 Drainage: we recommend that all exterior groundspots should be installed with a drainage level even when using a recessed housing.

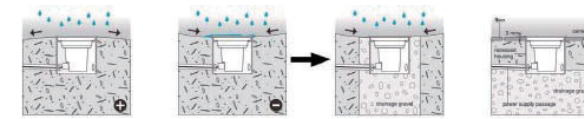

POWER CONNECTION

- 3 Connect to 220-240V and use waterproof connections.
- 4 Use screws to attach the fixture to the ground housing, screws are included.

CHART 1.2/1.6 & CHART ASYM 1.2/1.6

INSTALLATION INSTRUCTIONS | APRIL 2022

without ground housing

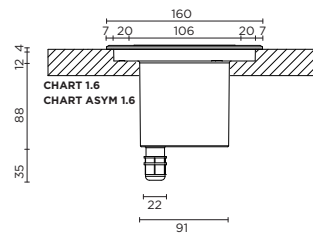
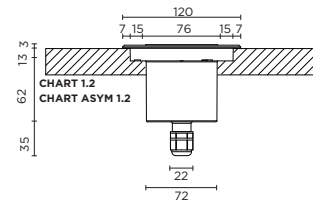
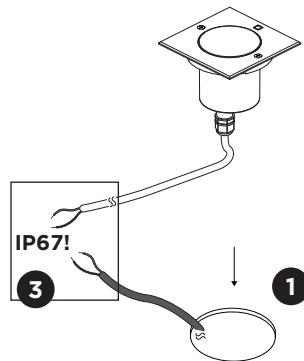

waterproof connection:

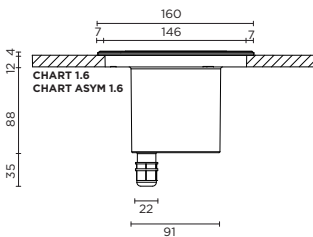
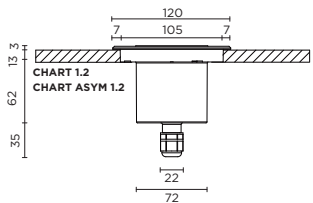
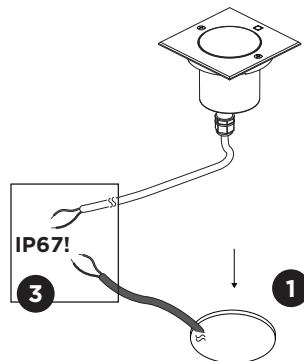
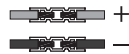

MOUNTING INSTRUCTION WITHOUT GROUND HOUSING

A. Attached to the floor (or wall, for wall mounting).

- Use the screws (included) to attach the luminaire to the floor or wall. Make sure to measure correctly so that you can screw into a hard material.

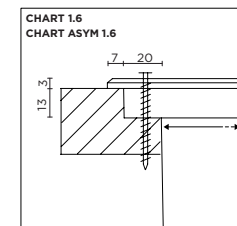
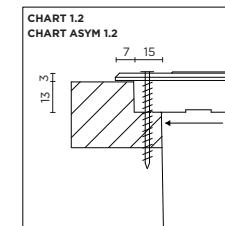

B. Rests on the stainless steel borders of the fixture.

- Place the luminaire into the hole. No tool is needed to fix the luminaire as it will rest on the stainless steel frame.

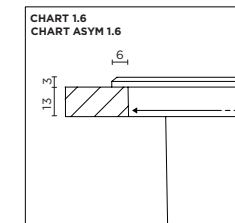
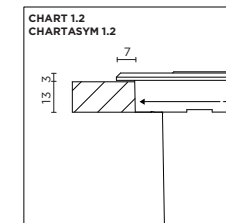

Note:
the bolts and
nuts can be used
for filling the
screwholes.

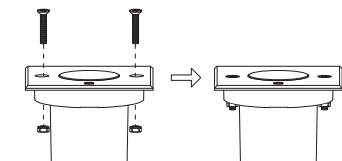
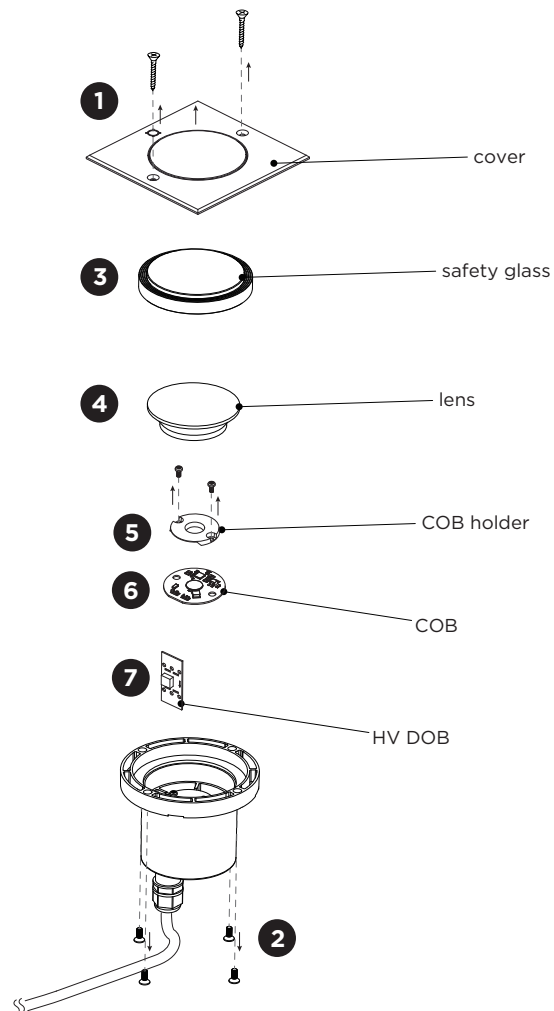

CHART 1.2/1.6 & CHART ASYM 1.2/1.6

INSTALLATION INSTRUCTIONS | APRIL 2022



DISMOUNTING INSTRUCTION

light source

- 1** Remove the screws and take out the fixture.
- 2** Remove the four screws below and remove the cover.
- 3** Remove the safety glass.
- 4** Remove the lens.
- 5** Remove the screws and the COB holder.
- 6** Disconnect the wires and remove the COB.
- 7** Remove the HV DOB.

To replace the light source please contact your Wever & Ducré customer service contact point.



This luminaire contains a light source with the energy class F.

